

LANSEN

QUICK INSTALLATION GUIDE

INDOOR LONG RANGE MAINS REPEATER WITH TWO EXTERNAL ANTENNAS
[LAN-WMBUS-RX4-M-LR-A1-X]



IMPORTANT!

Appropriate disconnection device, such as a power supply cable with socket, shall be used as part of the building instruction. It should be close to the device and easily accessible to the user. Furthermore, a 230 VAC installation MUST be carried out by authorized installer according to the relevant electrical safety regulations.

Recommended mounting instructions:

- Mount preferably on walls.
- Mount indoors protected from water. If higher IP-class is needed, then a Lansen sealing kit can be used (article number LAN-910-0042).
- Keep at least 30cm in all directions to other objects or walls/ceiling/floor.
- The label on the device should be on the left side.

Installation location and direction:

It is recommended to install the repeater indoors to a wall, but it can also be installed to the ceiling. It is highly recommended to mount the device as the image below.

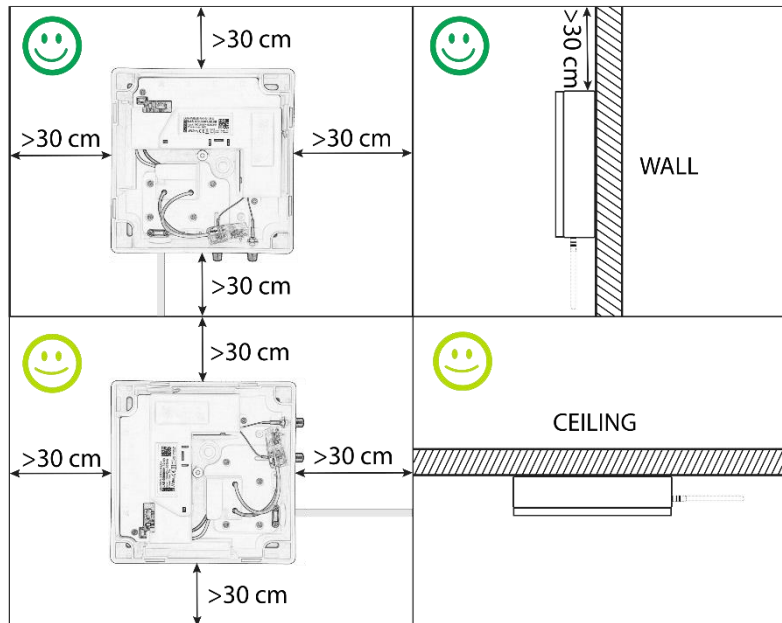

Step 1

Find a suitable place to install the repeater indoors. If the repeater is going to be used outdoors, then the repeater needs to be fitted with a Lansen sealing kit (article number LAN-910-0042).

Note: If a sealing kit is fitted, then the repeater is upgraded to A2-class. Follow the installation guide for LAN-WMBUS-RX4-M-LR-A2-X instead of this document.

Step 2

Unscrew the screw (marked with a red circle on the image below) and remove the cover by pushing the clips at both sides of the cover.

Note: The screw is a Security Torx T20H (with a small pin in the middle).

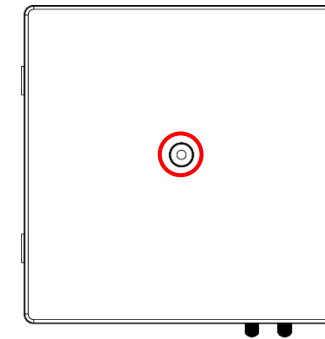

Step 3

The power supply cable can be mounted either through the cable guide at the bottom or through the hole on the back. By using the hole on the back, the repeater can be mounted directly on an outlet to hide cables.

- a. If the hole at the back is going to be used, go to **Step 4**.
- b. If the cable guide on the side is going to be used, go to **Step 5**.

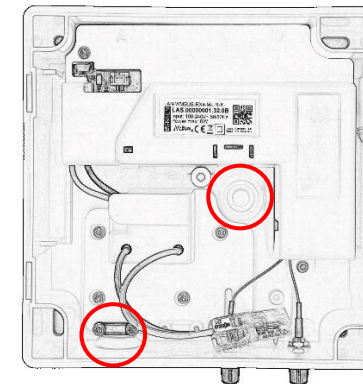

Step 4

Note: Do NOT use this for outdoor installations!

To use the hole at the back for a power supply cable, carefully cut, drill, or punch out the hole marked in the picture below.

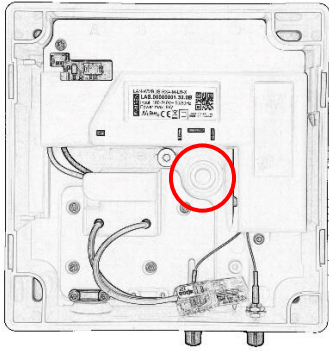

Step 5

Strip the power supply cable according to the diagram below.

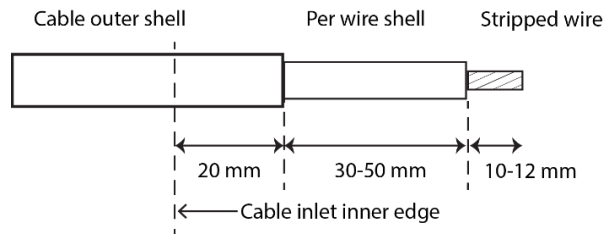

Step 6

Take the repeater and hold it where it is going to be mounted. Mark the holes (red circles), pre-drill if necessary (depending on the material), and mount the device by using four screws (not included).

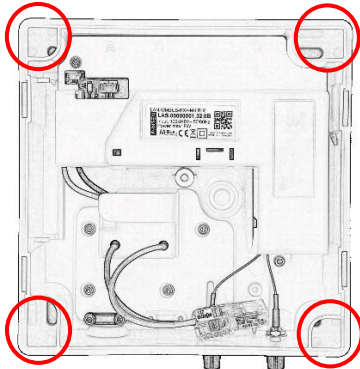

Step 7

Thread the power supply cable (prepared in Step 5) through the cable inlet, either from the back of the repeater or on the side (marked by red circles). Connect the power supply cable to the coupling clamps on the inside (marked by blue circle).

Note: If using the cable guide on the side, make sure to use the strain relief (marked by green circle) which is included in the package.

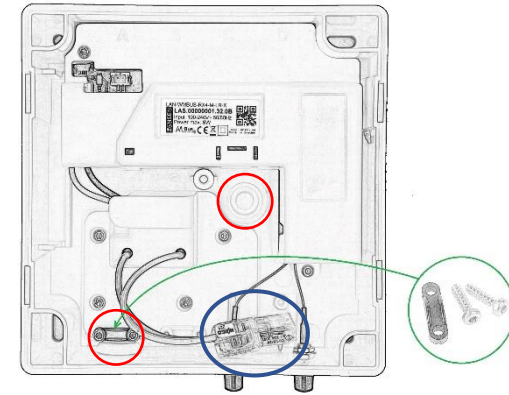

Step 8

Connect power to the repeater. A couple of seconds after power-on, a red LED will start blinking for every packet the repeater retransmits.

Note: If the red LED turns on for three seconds after power-on (~15s), this indicates a problem with the device. Please contact place of purchase.

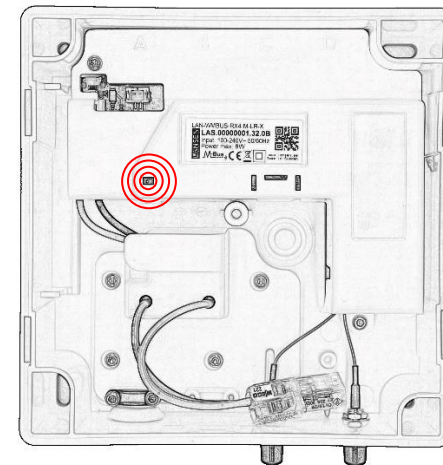

Step 9

Attach the cover and mount the screw (marked with a red circle on the image below). Make sure the clips at both sides of the cover are firmly attached.

Note: The screw is a Security Torx T20H (with a small pin in the middle).

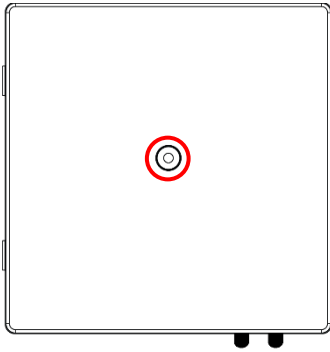

Step 10

Attach two external antennas to the device, either directly on the SMA connection (see left picture below) or with an antenna cable (see right picture below).

Typically, smaller antennas are mounted directly on the SMA connection while larger antennas require being mounted upright and with an antenna cable.

Note: Put receiving (RX) antenna on the connection closest to the corner

Note: Put transmitting (TX) antenna on the other connection (see below)

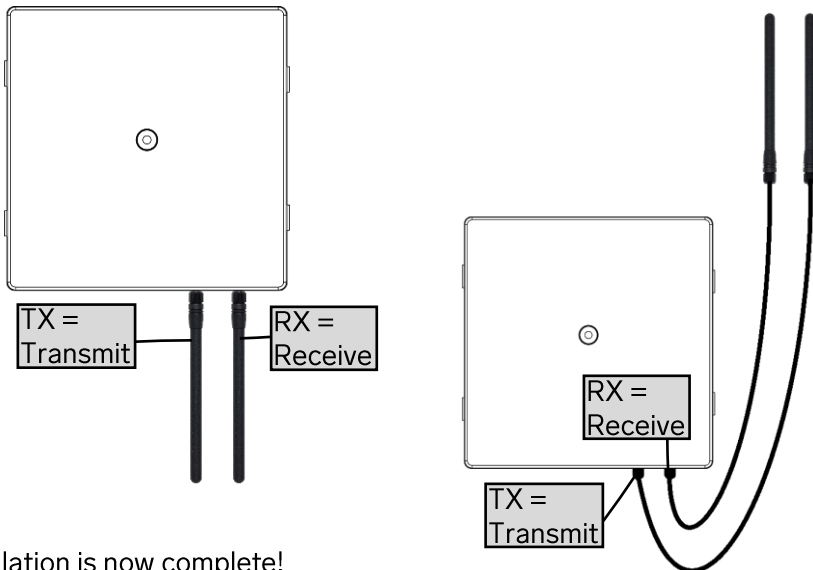

Installation is now complete!

Additional information

Please note that antennas and antenna cables are not included. See our full range of antennas, cables, and other accessories under our “accessories section”:

<https://www.lansensystems.com/assortment/accessories/>